



SOLUÇÕES PARA PORTAS

TRANSFORME O SEU PROJETO



As ferragens de porta são o que tornam uma porta móvel: usamo-las para ter controlo da entrada ou saída de uma divisão, através de uma porta.

Mas não têm apenas um objetivo funcional: as ferragens são, na verdade, **elementos que trabalham interligados e participam ativamente na criação de um ambiente em cada espaço.**

Este catálogo é assim o ponto de partida para o planeamento de todo o sistema de ferragens que permitem o perfeito funcionamento de uma porta interior. Desde o puxador ao batente de chão, apresentamos uma gama completa, com todas as ferragens necessárias à concretização do seu projeto, de forma rápida e eficiente.

SOLUÇÕES QUE VALORIZAM

PUXADORES E ACESSÓRIOS

PG. 04

ASAS PARA PORTA

PG. 22

FECHADURAS DE EMBUTIR

PG. 26

DOBRADIÇAS E PIVOTS

PG. 30

BATENTES DE CHÃO

PG. 34

VEDAPORTAS E VEDANTES

PG. 35

MOLAS DE PORTA

PG. 36

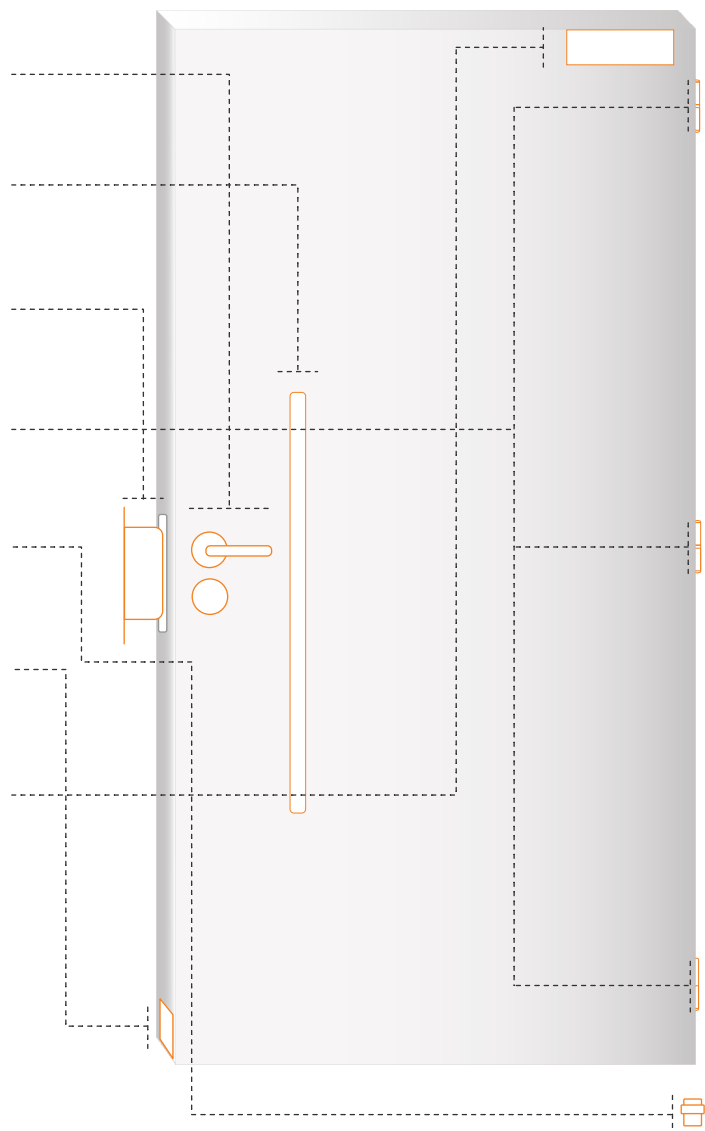

AS NOSSAS SOLUÇÕES

EXEMPLOS DE CONFIGURAÇÃO

GOLD

BLACK

IN.00.145.16.KN.TG

PUXADOR DE PORTA COM ROSETA

Ref: 206400211579



2275 5SQ 153

PUXADOR DE PORTA COM ROSETA

Ref: 212200223853

IN.04.28R.Y08N.TG

ENTRADA DE CHAVE YALE

Ref: 206403409308



4049 5SQ 153

ENTRADA DE CHAVE YALE

Ref: 212203423865

IN.20.855.TG

FECHADURA MAGNÉTICA

Ref: 206400423417



2868 153

FECHADURA MAGNÉTICA

Ref: 212200422883

IN230

DOBRADIÇA OCULTA

Ref: 248600127118



IN.05.061.B

DOBRADIÇA OCULTA

Ref: 206400120254

IN.13.121

BATENTE DE CHÃO

Ref: 206402021031



IN.13.356.TB

BATENTE DE CHÃO

Ref: 206401828096

IN.06.002

VEDAPORTAS SEM ABAS

Ref: 206402622330

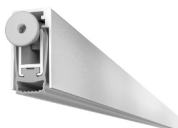

IN.06.004

VEDAPORTAS COM ABAS

Ref: 206402621872

ML.21.765

MOLA AÉREA DE SOBREPOR

Ref: 206409224168



ML.21.765

MOLA AÉREA DE SOBREPOR

Ref: 206409224168

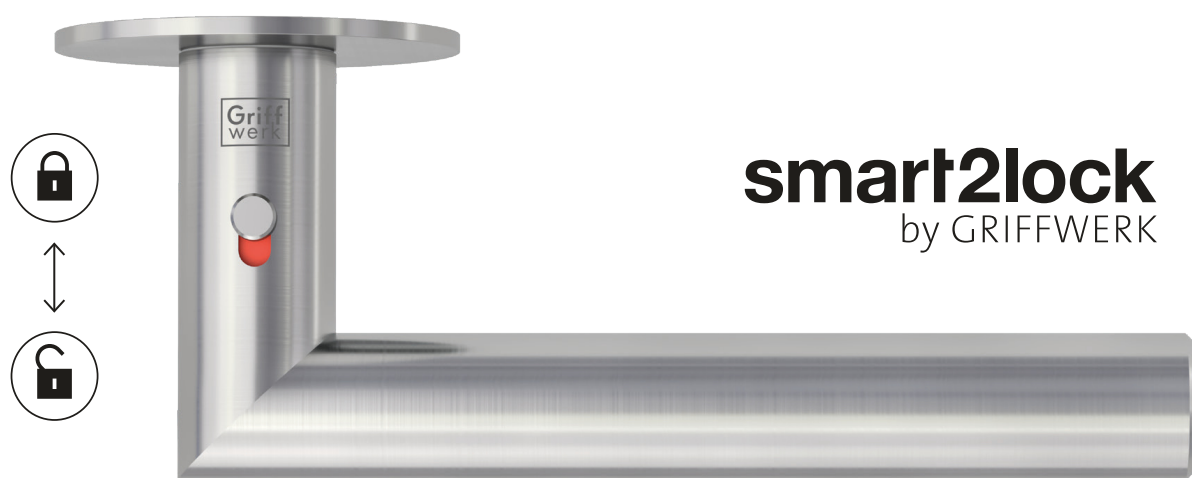

smart2lock
by GRIFFWERK

2 em 1. FECHA E TRANCA.

Privacidade com apenas um clique

A combinação perfeita entre tecnologia inteligente e design funcional

ADEQUADO A QUALQUER PORTA E QUALQUER CASA

VANTAGENS:

- Compatível com qualquer fechadura de embutir para portas de madeira
- Sistema de fecho integrado
- Abertura de emergência simples
- Sem necessidade de roseta

ADEQUADO A QUALQUER DIVISÃO



WC



QUARTO



ESCRITÓRIO



UMA NOVA ESTÉTICA DA PORTA

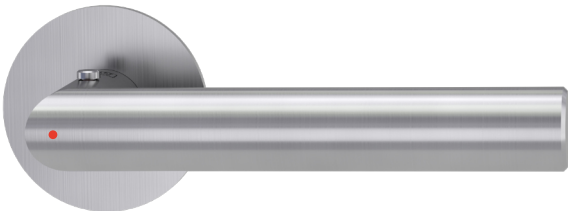

● AÇO INOX SATINADO

LUCIA PIATTA S SMART2LOCK

PUXADOR DE PORTA

Versão Esquerda
Ref: 200300225643

Versão Direita
Ref: 200300225644



● GRAPHITE BLACK

LUCIA PIATTA S SMART2LOCK

PUXADOR DE PORTA

Versão Esquerda
Ref: 200300228311

Versão Direita
Ref: 200300228312

Versão esquerda e direita definida de acordo com a norma **DIN 107**.

Para o mercado português, deverá seguir a **norma Tradicional**, contrária à norma DIN 107.

DIN 107 **DIN Tradicional**

Esquerda → Direita

Direita → Esquerda

GEOMETRIC SLIM SERIES

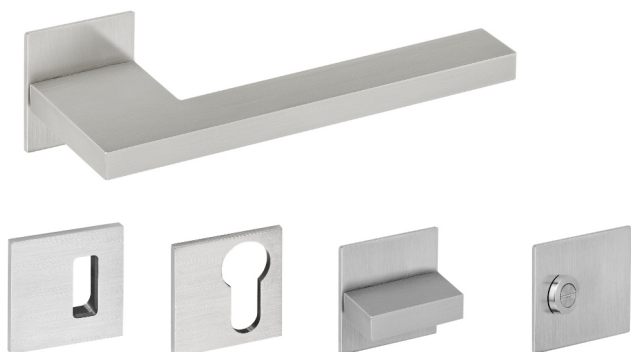

AÇO INOX
SATINADO

IN.00.432.Q.45

PUXADOR DE PORTA

Ref: 206400218651

IN.04.QP03SL

ENTRADA DE CHAVE NORMAL

Ref: 206403418652

IN.04.QY03SL

ENTRADA DE CHAVE PARA CILINDRO

Ref: 206403418281

IN.04.432

FECHO WC

Ref: 206400328166

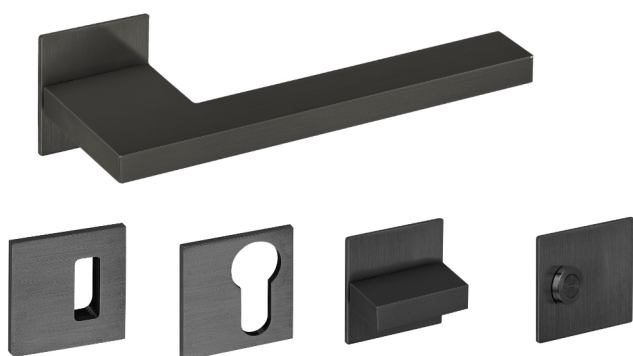

TITANIUM
BLACK (TB)

IN.00.432.Q.45.TB

PUXADOR DE PORTA

Ref: 206400228104

IN.04.QP03SL.TB

ENTRADA DE CHAVE NORMAL

Ref: 206403424928

IN.04.QY03SL.TB

ENTRADA DE CHAVE PARA CILINDRO

Ref: 206403428165

IN.04.432.TB

FECHO WC

Ref: 206400320851

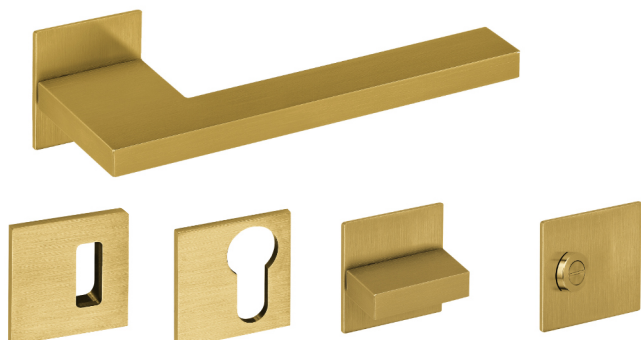

TITANIUM
GOLD (TG)

IN.00.432.Q.45.TG

PUXADOR DE PORTA

Ref: 206400220844

IN.04.QP03SL.TG

ENTRADA DE CHAVE NORMAL

Ref: 206403422280

IN.04.QY03SL.TG

ENTRADA DE CHAVE PARA CILINDRO

Ref: 206403422484

IN.04.432.TG

FECHO WC

Ref: 206400328167

STOUT WATCH SERIES



ÁÇO INOX
SATINADO

IN.00.145.16.KN

PUXADOR DE PORTA

Ref: 206400222505

IN.04.28R.P08N

ENTRADA DE CHAVE NORMAL

Ref: 206403409308

IN.04.28R.Y08N

ENTRADA DE CHAVE PARA CILINDRO

Ref: 206403406837

IN.04.266.KN

FECHO WC

Ref: 206400328112



TITANIUM
BLACK (TB)

IN.00.145.16.KN.TB

PUXADOR DE PORTA

Ref: 206400222271

IN.04.28R.P08N.TB

ENTRADA DE CHAVE NORMAL

Ref: 206403421045

IN.04.28R.Y08N.TB

ENTRADA DE CHAVE PARA CILINDRO

Ref: 206403421051

IN.04.266.KN.TB

FECHO WC

Ref: 206400326952



TITANIUM
GOLD (TG)

IN.00.145.16.KN.TG

PUXADOR DE PORTA

Ref: 206400223069

IN.04.28R.P08N.TG

ENTRADA DE CHAVE NORMAL

Ref: 206403421470

IN.04.28R.Y08N.TG

ENTRADA DE CHAVE PARA CILINDRO

Ref: 206403422420

IN.04.266.KN.TG

FECHO WC

Ref: 206400322530

A SUA COMBINAÇÃO

A SUA PORTA

Uma gama de puxadores e acessórios especialmente selecionada para lhe conferir todo o poder de personalização.

Altamente versátil, o sistema adapta-se a qualquer porta e ambiente.

1. Defina um modelo

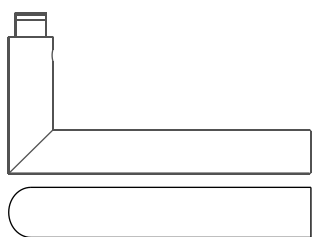

IN.00.030

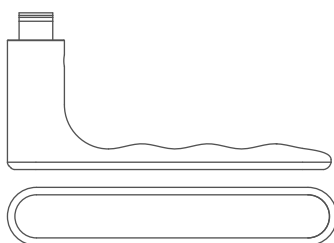

IN.00.177

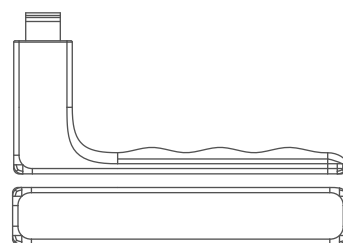

IN.00.178

2. Escolha o seu acabamento preferido



AÇO INOX
SATINADO



TITANIUM
BLACK
(.TB)



TITANIUM
GOLD
(.TG)

3. Escolha um formato e espessura para os acessórios

SISTEMA DE ACESSÓRIOS 8 MM

SISTEMA DE ACESSÓRIOS 1 MM LESS IS MORE

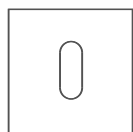
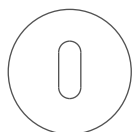
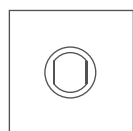
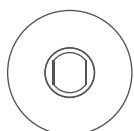

SISTEMA DE ACESSÓRIOS 1 MM EVEN LESS



PUXADORES DE PORTA

SISTEMA LIVRE DE PUXADORES E ACESSÓRIOS

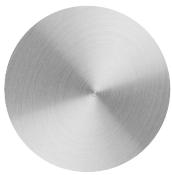

AÇO INOX
SÁTINADO

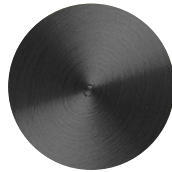

TITANIUM
BLACK
(.TB)



TITANIUM
GOLD
(.TG)



IN.00.030.SR

PUXADOR DE PORTA SEM ROSETA

Ref: 206400211579



IN.00.030.TB.SR

PUXADOR DE PORTA SEM ROSETA

Ref: 206400222522



IN.00.030.TG.SR

PUXADOR DE PORTA SEM ROSETA

Ref: 206400227250



IN.00.177.SR

PUXADOR DE PORTA SEM ROSETA

Ref: 206400228043



IN.00.177.TB.SR

PUXADOR DE PORTA SEM ROSETA

Ref: 206400228334



IN.00.177.TG.SR

PUXADOR DE PORTA SEM ROSETA

Ref: 206400228101



IN.00.178.SR

PUXADOR DE PORTA SEM ROSETA

Ref: 206400225736



IN.00.178.TB.SR

PUXADOR DE PORTA SEM ROSETA

Ref: 206400228102



IN.00.178.TG.SR

PUXADOR DE PORTA SEM ROSETA

Ref: 206400228103

ACESSÓRIOS DE 8 MM

SISTEMA LIVRE DE PUXADORES E ACESSÓRIOS



RC08M
ROSETA

Ref: 206403419800

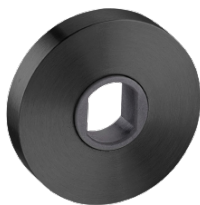

RC08M.TB
ROSETA

Ref: 206403427092



RC08M.TG
ROSETA

Ref: 206403423626



IN.04.28R.P08N
ENTRADA DE CHAVE NORMAL

Ref: 206403409308



IN.04.28R.P08N.TB
ENTRADA DE CHAVE NORMAL

Ref: 206403421045



IN.04.28R.P08N.TG
ENTRADA DE CHAVE NORMAL

Ref: 206403421470



IN.04.28R.Y08N
ENTRADA DE CHAVE PARA CILINDRO

Ref: 206403406837



IN.04.28R.Y08N.TB
ENTRADA DE CHAVE PARA CILINDRO

Ref: 206403421051



IN.04.28R.Y08N.TG
ENTRADA DE CHAVE PARA CILINDRO

Ref: 206403422420



IN.04.112
FECHO WC

Ref: 206400316152



IN.04.112.TB
FECHO WC

Ref: 206400320726



IN.04.112.TG
FECHO WC

Ref: 206400322429



QC08M
ROSETA

Ref: 206403417642



QC08M.TB
ROSETA

Ref: 206403428106



QC08M.TG
ROSETA

Ref: 206403428107



IN.04.29Q.P08N
ENTRADA DE CHAVE NORMAL

Ref: 206403408592



IN.04.29Q.P08N.TB
ENTRADA DE CHAVE NORMAL

Ref: 206403409026



IN.04.29Q.P08N.TG
ENTRADA DE CHAVE NORMAL

Ref: 206403422422



IN.04.29Q.Y08N
ENTRADA DE CHAVE PARA CILINDRO

Ref: 206403408590



IN.04.29Q.Y08N.TB
ENTRADA DE CHAVE PARA CILINDRO

Ref: 206403420103



IN.04.29Q.Y08N.TG
ENTRADA DE CHAVE PARA CILINDRO

Ref: 206403428115



IN.04.246
FECHO WC

Ref: 206400308255



IN.04.246.TB
FECHO WC

Ref: 206400322475



IN.04.246.TG
FECHO WC

Ref: 206400322476

ACESSÓRIOS DE 1 MM LESS IS MORE

SISTEMA LIVRE DE PUXADORES E ACESSÓRIOS



Usado recomendado com fechaduras para **uso intensivo**



R01N
ROSETA

Ref: 206403423979



R01N.TB
ROSETA

Ref: 206403427925



R01N.TG
ROSETA

Ref: 206403425582

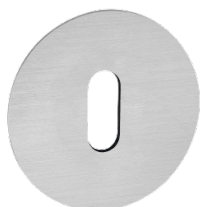

IN.04.RP01N
ENTRADA DE CHAVE NORMAL

Ref: 206403424019

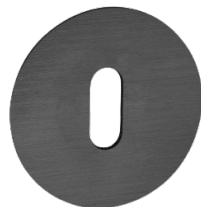

IN.04.RP01N.TB
ENTRADA DE CHAVE NORMAL

Ref: 206403426664



IN.04.RP01N.TG
ENTRADA DE CHAVE NORMAL

Ref: 206403425587



IN.04.RY01MB
ENTRADA DE CHAVE PARA CILINDRO

Ref: 206403408767



IN.04.RY01MB.TB
ENTRADA DE CHAVE PARA CILINDRO

Ref: 206403428118



IN.04.RY01MB.TG
ENTRADA DE CHAVE PARA CILINDRO

Ref: 206403426420

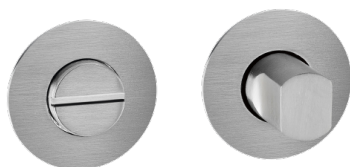

IN.04.003
FECHO WC

Ref: 206400324345

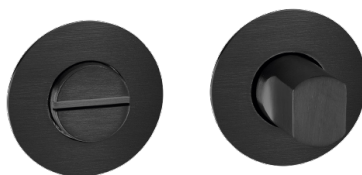

IN.04.003.TB
FECHO WC

Ref: 206400328116

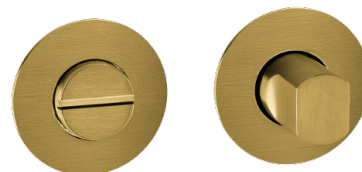

IN.04.003.TG
FECHO WC

Ref: 206400325889



Q01N
ROSETA

Ref: 206403428044

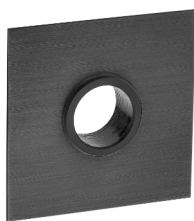

Q01N.TB
ROSETA

Ref: 206403428108



Q01N.TG
ROSETA

Ref: 206403428109

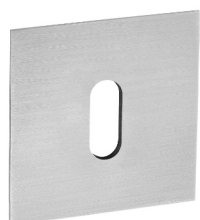

IN.04.QP01N
ENTRADA DE CHAVE NORMAL

Ref: 206403428049

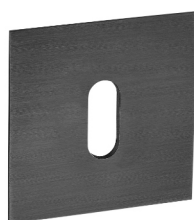

IN.04.QP01N.TB
ENTRADA DE CHAVE NORMAL

Ref: 206403428119



IN.04.QP01N.TG
ENTRADA DE CHAVE NORMAL

Ref: 206403428120



IN.04.QY01N
ENTRADA DE CHAVE PARA CILINDRO

Ref: 206403427957



IN.04.QY01N.TB
ENTRADA DE CHAVE PARA CILINDRO

Ref: 206403429017



IN.04.QY01N.TG
ENTRADA DE CHAVE PARA CILINDRO

Ref: 206403429018

ACESSÓRIOS DE 1 MM EVEN LESS

SISTEMA LIVRE DE PUXADORES E ACESSÓRIOS



Uso recomendado
com fechaduras
para **uso intensivo**

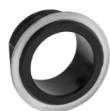

R01NS
ROSETA

Ref: 206403426845



R01NS.TB
ROSETA

Ref: 206400225824

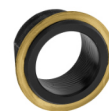

R01NS.TG
ROSETA

Ref: 206403428105



IN.04.RP01NS
ENTRADA DE CHAVE NORMAL

Ref: 206403427103



IN.04.RP01NS.TB
ENTRADA DE CHAVE NORMAL

Ref: 206403425825



IN.04.RP01NS.TG
ENTRADA DE CHAVE NORMAL

Ref: 206403428121



IN.04.RY01S
ENTRADA DE CHAVE PARA CILINDRO

Ref: 206403416311



IN.04.RY01S.TB
ENTRADA DE CHAVE PARA CILINDRO

Ref: 206403428122



IN.04.RY01S.TG
ENTRADA DE CHAVE PARA CILINDRO

Ref: 206403428123

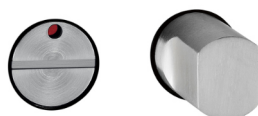

IN.04.008
FECHO WC

Ref: 206400323711



IN.04.008.TB
FECHO WC

Ref: 206400328117



IN.04.008.TG
FECHO WC

Ref: 206400326885

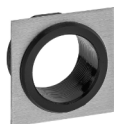

Q01NS
ROSETA

Ref: 206403428045

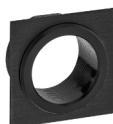

Q01NS.TB
ROSETA

Ref: 206403428110

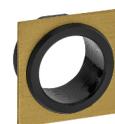

Q01NS.TG
ROSETA

Ref: 206403428111



IN.04.QP01NS
ENTRADA DE CHAVE NORMAL

Ref: 206403426987



IN.04.QP01NS.TB
ENTRADA DE CHAVE NORMAL

Ref: 206403428126



IN.04.QP01NS.TG
ENTRADA DE CHAVE NORMAL

Ref: 206403428127

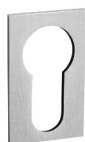

IN.04.QY01S
ENTRADA DE CHAVE PARA CILINDRO

Ref: 206403415105



IN.04.QY01S.TB
ENTRADA DE CHAVE PARA CILINDRO

Ref: 206403428124



IN.04.QY01S.TG
ENTRADA DE CHAVE PARA CILINDRO

Ref: 206403428125

EXCLUSIVOS

Uma gama de puxadores e acessórios com espessura de 5 mm

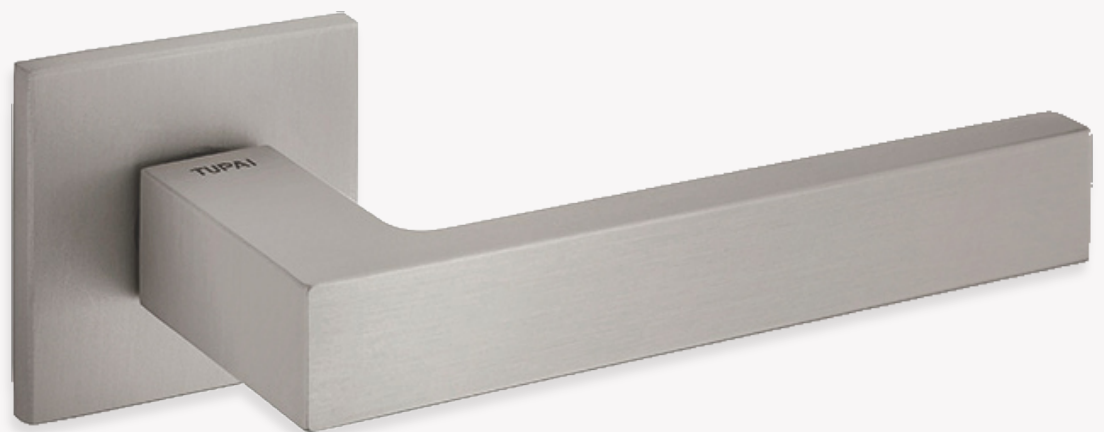
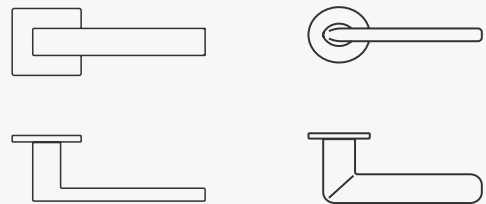

SATINADO

NIQUELADO
PÉROLA

PRETO
PÉROLA

Imagem:

2275 5SQ em Niquelado Pérola

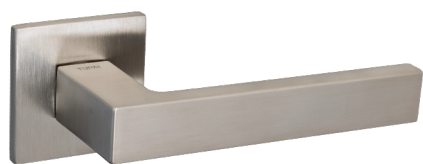

● SATINADO EFEITO INOX

2275 5SQ 110
PUXADOR DE PORTA

Ref: 212200223461

4048 5SQ 110
ENTRADA DE CHAVE NORMAL

Ref: 212203423462

4049 5SQ 110
ENTRADA DE CHAVE PARA CILINDRO

Ref: 212203423866

4040 5SQ 110
FECHO PARA WC

Ref: 212200322778

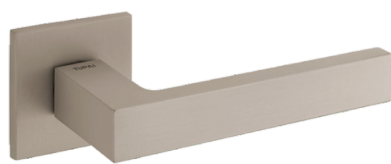

● NIQUELADO PÉROLA

2275 5SQ 142
PUXADOR DE PORTA

Ref: 212200223854

4048 5SQ 142
ENTRADA DE CHAVE NORMAL

Ref: 212203422064

4049 5SQ 142
ENTRADA DE CHAVE PARA CILINDRO

Ref: 212203422355

4040 5SQ 142
FECHO PARA WC

Ref: 212200321128



● PRETO PÉROLA

2275 5SQ 153
PUXADOR DE PORTA

Ref: 212200223853

4048 5SQ 153
ENTRADA DE CHAVE NORMAL

Ref: 212203422068

4049 5SQ 153
ENTRADA DE CHAVE PARA CILINDRO

Ref: 212203423865

4040 5SQ 153
FECHO PARA WC

Ref: 212200323413



● PRETO PÉROLA

3953 5S 153
PUXADOR DE PORTA

Ref: 212200222144

4045 5S 153
ENTRADA DE CHAVE NORMAL

Ref: 212203422062

4046 5S 153
ENTRADA DE CHAVE PARA CILINDRO

Ref: 212203421868

4041 5S 153
FECHO PARA WC

Ref: 212200325339



● NIQUELADO PÉROLA

3953 5S 142
PUXADOR DE PORTA

Ref: 212200222059

4045 5S 142
ENTRADA DE CHAVE NORMAL

Ref: 212203422060

4046 5S 142
ENTRADA DE CHAVE PARA CILINDRO

Ref: 212203424578

4041 5S 142
FECHO PARA WC

Ref: 212200324825



○ BRANCO PÉROLA

3953 5S 152
PUXADOR DE PORTA

Ref: 212200225523

4045 5S 152
ENTRADA DE CHAVE NORMAL

Ref: 212203422043

4046 5S 152
ENTRADA DE CHAVE PARA CILINDRO

Ref: 212203423829

4041 5S 152
FECHO PARA WC

Ref: 212200326446





● AÇO INOX SATINADO

2001 16
PUXADOR DE PORTA

2001+2008- 16
PUXADOR DE PORTA + ENTRADA DE CHAVE NORMAL
Ref: 212200229268

2001+2009- 16
PUXADOR DE PORTA + ENTRADA DE CHAVE PARA CILINDRO
Ref: 212200229269

2147 16
FECHO WC
Ref: 212200318629



● PRETO PÉROLA

2001 153
PUXADOR DE PORTA
Ref: 212200222115

2008 153
ENTRADA DE CHAVE NORMAL
Ref: 212203422116

2009 153
ENTRADA DE CHAVE PARA CILINDRO
Ref: 212203422265

2147 153
FECHO WC
Ref: 212200322886



● AÇO INOX SATINADO

2002 16
PUXADOR DE PORTA

2002+2008- 16
PUXADOR DE PORTA + ENTRADA DE CHAVE NORMAL
Ref: 212200227826

2002+2009- 16
PUXADOR DE PORTA + ENTRADA DE CHAVE PARA CILINDRO
Ref: 212200227827

2147 16
FECHO WC
Ref: 212200318629



● PRETO PÉROLA

2002 153
PUXADOR DE PORTA
Ref: 212200226012

2008 153
ENTRADA DE CHAVE NORMAL
Ref: 212203422116

2009 153
ENTRADA DE CHAVE PARA CILINDRO
Ref: 212203422265

2147 153
FECHO WC
Ref: 212200322886



PUXADORES DE PORTA

PUXADORES FIXOS E ROTATIVOS



● AÇO INOX SATINADO

IN.00.111
PUXADOR FIXO
Ref: 206400208326

IN.00.110
PUXADOR ROTATIVO
Ref: 206400208703



● TITANIUM BLACK

IN.00.111.TB
PUXADOR FIXO
Ref: 206400223662

IN.00.110.TB
PUXADOR ROTATIVO
Ref: 206400223909

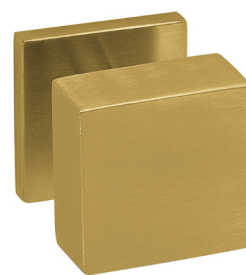

● TITANIUM GOLD

IN.00.111.TG
PUXADOR FIXO
Ref: 206400225920

IN.00.110.TG
PUXADOR ROTATIVO
Ref: 206400225921



● AÇO INOX SATINADO

IN.00.202.F
PUXADOR FIXO
Ref: 206400223635

IN.00.202
PUXADOR ROTATIVO
Ref: 206400220345



● TITANIUM BLACK

IN.00.202.F.TB
PUXADOR FIXO
Ref: 206400228113

IN.00.202.TB
PUXADOR ROTATIVO
Ref: 206400228329



● TITANIUM GOLD

IN.00.202.F.TG
PUXADOR FIXO
Ref: 206400228114

IN.00.202.TG
PUXADOR ROTATIVO
Ref: 206400228330



● AÇO INOX SATINADO

IN.00.090
PUXADOR FIXO
Ref: 206400203202

IN.00.090.G
PUXADOR ROTATIVO
Ref: 206400203902



● TITANIUM BLACK

IN.00.090.TB
PUXADOR FIXO
Ref: 206400221473

IN.00.090.G.TB
PUXADOR ROTATIVO
Ref: 206400221457



● TITANIUM GOLD

IN.00.090.TG
PUXADOR FIXO
Ref: 206400222424

IN.00.090.G.TG
PUXADOR ROTATIVO
Ref: 206400222423

ASAS DE PORTA

ERGO CONFORT SERIES

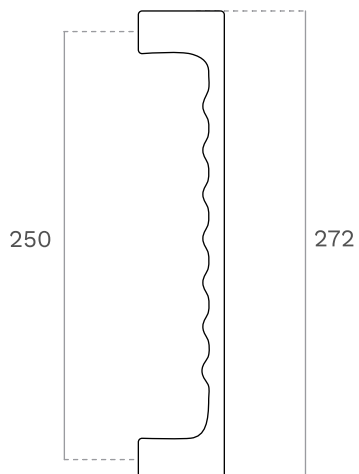

 AÇO INOX SATINADO

IN.07.177.D
ASA DUPLA
Ref: 206401025215



 TITANIUM BLACK

IN.07.177.TB.D
ASA DUPLA
Ref: 206401024164



 TITANIUM GOLD

IN.07.177.TG.D
ASA DUPLA
Ref: 206401028128

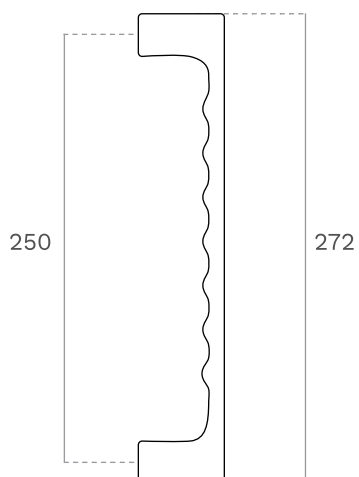

 AÇO INOX SATINADO

IN.07.178.D
ASA DUPLA
Ref: 206401028046



 TITANIUM BLACK

IN.07.178.TB.D
ASA DUPLA
Ref: 206401028093



 TITANIUM GOLD

IN.07.178.TG.D
ASA DUPLA
Ref: 206401028129

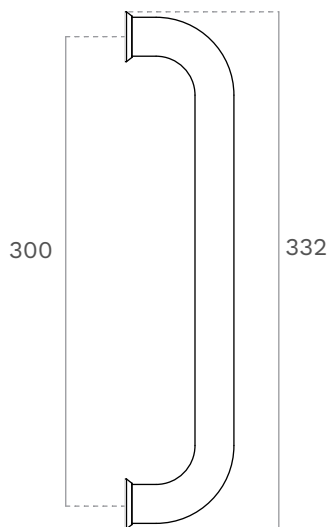

● AÇO INOX SATINADO
IN.07.020.A
 ASA DUPLA
 Ref: 206401023621



● TITANIUM BLACK
IN.07.020.A.TB
 ASA DUPLA
 Ref: 206401028050



● TITANIUM GOLD
IN.07.020.A.TG
 ASA DUPLA
 Ref: 206401028051

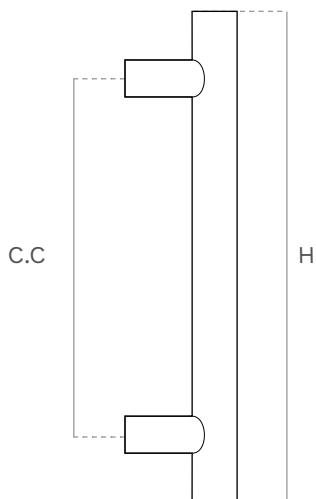

● AÇO INOX SATINADO
IN.07.286.D.25
 ASA DUPLA
H:450 mm | C.C.: 300 mm
 Ref: 206401016300
H:600 mm | C.C.: 450 mm
 Ref: 206401022006



● TITANIUM BLACK
IN.07.286.D.25.TB
 ASA DUPLA
H:450 mm | C.C.: 300 mm
 Ref: 206401028132
H:600 mm | C.C.: 450 mm
 Ref: 206401028134



● TITANIUM GOLD
IN.07.286.D.25.TG
 ASA DUPLA
H:450 mm | C.C.: 300 mm
 Ref: 206401028133
H:600 mm | C.C.: 450 mm
 Ref: 206401028135

ASAS DE PORTA

GEOMETRIC SLIM SERIES

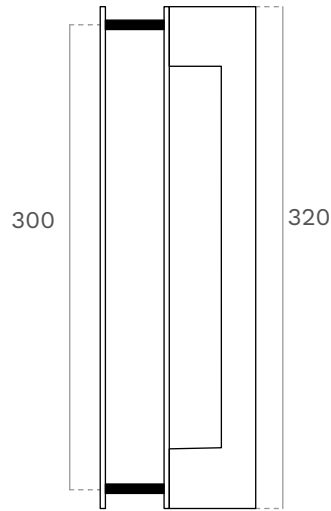
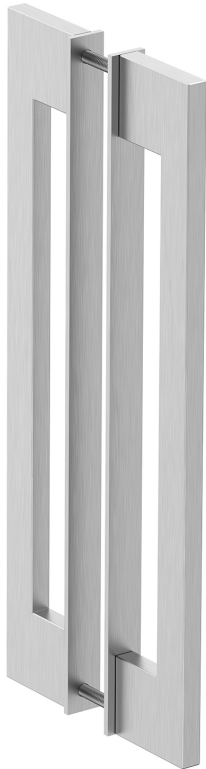

 AÇO INOX SATINADO
IN.07.432.D
ASA DUPLA
Ref: 206401028130

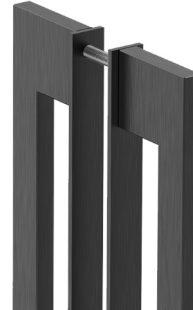

 TITANIUM BLACK
IN.07.432.D.TB
ASA DUPLA
Ref: 206401028094



 TITANIUM GOLD
IN.07.432.D.TG
ASA DUPLA
Ref: 206401028095

STOUT WATCH SERIES

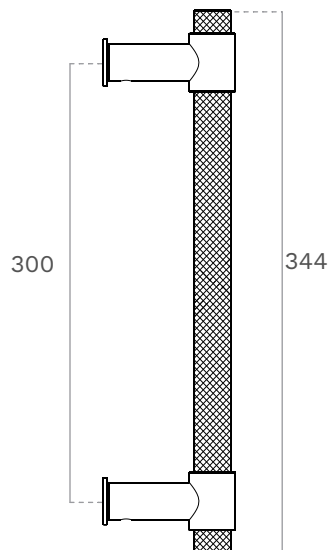
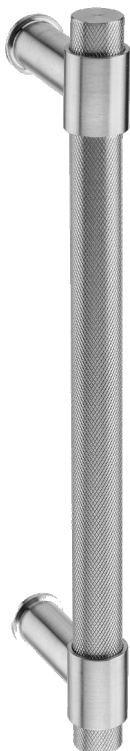

 AÇO INOX SATINADO
IN.07.123.16.D.KN
ASA DUPLA
H:300mm
Ref: 106401425997



 TITANIUM BLACK
IN.07.123.16.D.KN.TB
ASA DUPLA
H:300mm
Ref: 206401028131



 TITANIUM GOLD
IN.07.123.16.D.KN.TG
ASA DUPLA
H:300mm
Ref: 206401022224

GEOMETRIC SLIM

SERIES





FECHADURAS

DE EMBUTIR

IN.20.275

FECHADURA PARA CILINDRO



Indicada para portas com uso **elevado**.

Quadra com mola interior para eliminação da folga entre o puxador e a mola.

● AÇO INOX SATINADO
Ref: 206400428047

IN.20.825.R

FECHADURA PARA CILINDRO



Indicada para portas com **uso médio**.

Quadra com mola interior para eliminação entre o puxador e a mola.

Trinco silencioso reversível com silenciador intermédio em nylon.

Fornecida com chapa testa ajustável e reversível.

● AÇO INOX SATINADO
Ref: 206400413327

● TITANIUM BLACK
Ref: 206400428137

● TITANIUM GOLD
Ref: 206400428136

719 MN

FECHADURA PARA CHAVE NORMAL

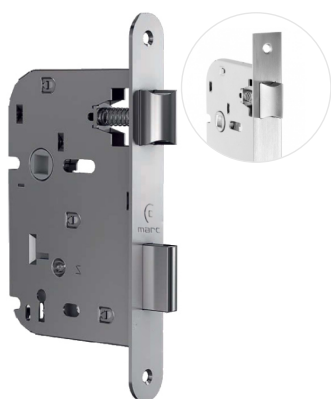

Indicada para portas com **uso ligeiro**.

6 combinações de chave normal.

Fornecida com chapa testa.

Cantos redondos
● AÇO INOX SATINADO
Ref: 273400414934

Cantos retos
● AÇO INOX SATINADO
Ref: 273400414899

FECHADURAS

ACESSÓRIOS COMPATÍVEIS

IN.19.S40.TB

CILINDRO DE ALTA SEGURANÇA



Sistema de **Dupla Ação.**

Resistente ao fogo.

Resistente à corrosão.

Resistente ao ataque.

Aplicação: edifícios com elevados padrões de alta segurança, indústria, hotelaria, ensino, saúde, segurança privada, etc.

● TITANIUM BLACK

60 mm (30x30)

Ref: 206402224596

80 mm (30x50)

Ref: 206402228194

IN.19.S40.CC

CHAVE INCOPIÁVEL



IN.20.AKN | ADAPTADOR EM NYLON

Converte fechaduras de cilindro em chave normal.

12 combinações possíveis.

IN.20.AWC | ADAPTADOR EM NYLON

Ref: 206400419657

Converte fechaduras de cilindro em fechaduras para WC.

Pode ser aplicado com quadras de 6x6 ou 8x8 mm.



FECHADURAS

MAGNÉTICAS

2867

FECHADURA MAGNÉTICA PARA CHAVE NORMAL



Fechadura para portas interiores.
Chapa testa ajustável.
Fornecida com 1 chave.

● NIQUELADO SATINADO
Ref: 212200418506

● PRETO PÉROLA
Ref: 212200400554

○ BRANCO PÉROLA
Ref: 212200425527

2868

FECHADURA MAGNÉTICA PARA CILINDRO



Fechadura para cilindro.
Quadra 8x8.

● NIQUELADO SATINADO
Ref: 212200420152

● PRETO PÉROLA
Ref: 212200422883

○ BRANCO PÉROLA
Ref: 212200429671

2869

FECHADURA MAGNÉTICA PARA WC



Fechadura para WC.
Quadra 8x8.

● NIQUELADO SATINADO
Ref: 212200419150

● PRETO PÉROLA
Ref: 212200422882

○ BRANCO PÉROLA
Ref: 212200429672

NO-HA Mini

FECHADURA MAGNÉTICA PARA WC



A primeira fechadura magnética sem necessidade de puxador.

Abertura/fecho da porta: movimento silencioso e fluído.

Resistente à oxidação.

Não requer manutenção.

Fornecida com chapa testa ajustável.

● CROMADO SATINADO
Ref: 283600417866

IN.20.805.60

FECHADURA MAGNÉTICA PARA CILINDRO



Indicada para portas com **uso médio**.

Quadra com mola interior para eliminação entre o puxador e a mola.

Chapa testa ajustável e reversível.

● AÇO INOX SATINADO
Ref: 206400419681

● TITANIUM BLACK
Ref: 206400422274

● TITANIUM GOLD
Ref: 206400425876

IN.20.855.R

FECHADURA MAGNÉTICA PARA CILINDRO



Indicada para portas com **uso intensivo**.

Quadra com mola interior para eliminação entre o puxador e a mola.

Trinco magnético silencioso e reversível.

Chapa testa magnética reversível e ajustável.

● AÇO INOX SATINADO
Ref: 206400422696

● TITANIUM BLACK
Ref: 206400425206

● TITANIUM GOLD
Ref: 206400423417



DOBRADIÇAS E PIVOTS

DOBRADIÇAS DE PORTA

IN.05.019.75.ECO

DOBRADIÇA DE MEIO BALANÇO



● AÇO INOX SATINADO
 Esquerda | Ref: 206400119256
 Direita | Ref: 206400119257

● PRETO SATINADO
 Esquerda | Ref: 206400121393
 Direita | Ref: 206400121394

IN.05.019.75.R.ECO

DOBRADIÇA DE MEIO BALANÇO



● AÇO INOX SATINADO
 Esquerda | Ref: 206400119260
 Direita | Ref: 206400119261

IN.05.019.90.BR.ECO

DOBRADIÇA DE MEIO BALANÇO



● AÇO INOX SATINADO
 Esquerda | Ref: 206400119276
 Direita | Ref: 206400119277

S-1855 | S-1847

DOBRADIÇAS COM MOLDA DE DUPLA AÇÃO



S-1855 | CANTOS RETOS
 ● AÇO INOX SATINADO
 Esquerda | Ref: 212200118588
 Direita | Ref: 212200118587

S-1847 | CANTOS REDONDOS
 ● AÇO INOX SATINADO
 Esquerda | Ref: 212200118586
 Direita | Ref: 212200118585

DOBRADIÇAS E PIVOTS

PIVOTS

3184

DOBRADIÇA PIVOTANTE

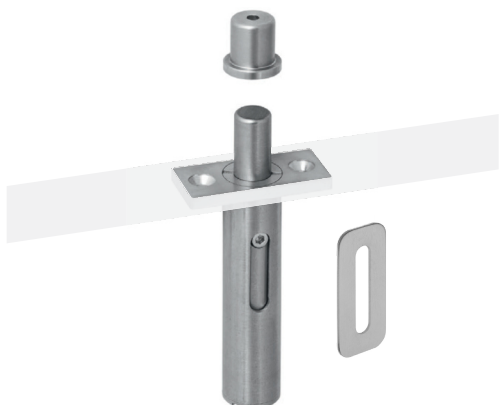

Fácil aplicação na porta, permitindo a montagem e desmontagem da mesma.

Espelho de acesso incluído para desmontagem da porta.

A instalação do espelho de acesso permite desmontar a porta.

● AÇO INOX SATINADO

Ref: 212200126842

IN.05.204

PIVOT HIDRÁULICO PARA PORTAS BATENTE

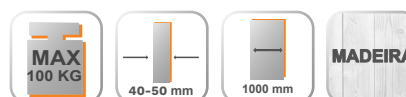

Aplicação à superfície do pavimento sem trabalho de alvernaria.

Fecho suave.

Paragem a 90°.

Duas velocidades de fecho reguláveis por válvulas.

● AÇO INOX SATINADO

Ref: 106408615798

IN.05.196.0

GIRO PARA PORTAS DE BATENTE



● AÇO INOX SATINADO

Ref: 106408612829

DOBRADIÇAS E PIVOTS

DOBRADIÇAS OCULTAS



IN230

DOBRADIÇA OCULTA CORTA-FOGO



● NIQUELADO SATINADO

Ref: 248600119592

● PRETO MATE

Ref: 248600123584

● DOURADO POLIDO

Ref: 248600127118

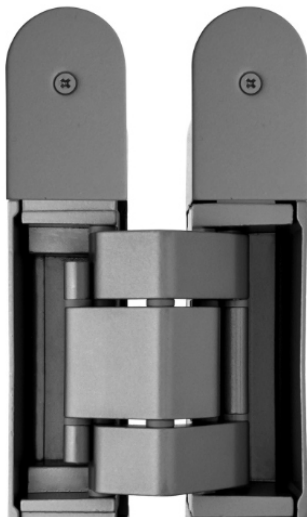

IN310

DOBRADIÇA OCULTA CORTA-FOGO



● NIQUELADO SATINADO

Ref: 248600122240

IN235

DOBRADIÇA OCULTA



● NIQUELADO SATINADO

Ref: 248600119591



IN.05.064
DOBRADIÇA OCULTA
Ref: 206400123303



IN.05.061
DOBRADIÇA OCULTA
Ref: 206400117377



IN.05.062
DOBRADIÇA OCULTA
Ref: 206400118461

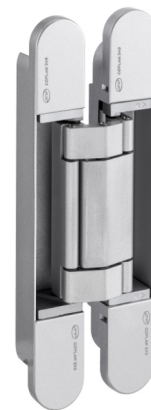

IN.05.063
DOBRADIÇA OCULTA
Ref: 206400121840



IN.05.064.B
DOBRADIÇA OCULTA
Ref: 206400123926



IN.05.061.B
DOBRADIÇA OCULTA
Ref: 206400120254



IN.05.062.B
DOBRADIÇA OCULTA
Ref: 206400120290



IN.05.063.B
DOBRADIÇA OCULTA
Ref: 206400123783

OPCIONAL

TAMPAS DECORATIVAS EM AÇO INOX

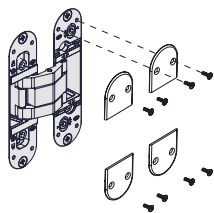

● AÇO INOX SATINADO

IN.05.___.C
TAMPAS DECORATIVAS

IN.05.064.C
Ref: 206400128382

IN.05.061.C
Ref: 206400117832

IN.05.062.C
Ref: 206400118462

IN.05.063.C
Ref: 206400128379

● TITANIUM BLACK

IN.05.___.C.TB
TAMPAS DECORATIVAS

IN.05.064.C.TB
Ref: 206400127874

IN.05.061.C.TB
Ref: 206400123247

IN.05.062.C.TB
Ref: 206400128378

IN.05.063.C.TB
Ref: 206400128380

● TITANIUM GOLD

IN.05.___.C.TG
TAMPAS DECORATIVAS

IN.05.064.C.TG
Ref: 206400123984

IN.05.061.C.TG
Ref: 206400123248

IN.05.062.C.TG
Ref: 206400124565

IN.05.063.C.TG
Ref: 206400128381

BATENTES

DE CHÃO



 AÇO INOX SATINADO

IN.13.121
BATENTE DE CHÃO

Ø 20 mm

Ref: 206401805507

Ø 30 mm

Ref: 206402015029



 TITANIUM BLACK

IN.13.121.TB
BATENTE DE CHÃO

Ø 20 mm

Ref: 206402020901

Ø 30 mm

Ref: 206402023363



 TITANIUM GOLD

IN.13.121.TG
BATENTE DE CHÃO

Ø 20 mm

Ref: 206402021031

Ø 30 mm

Ref: 206402023416

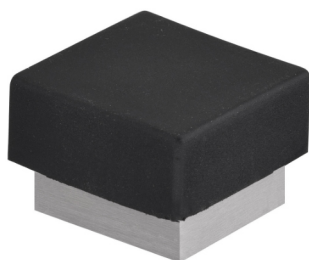

 AÇO INOX SATINADO

IN.13.356
BATENTE DE CHÃO

Ref: 206401815980



 TITANIUM BLACK

IN.13.356.TB
BATENTE DE CHÃO

Ref: 206401828096

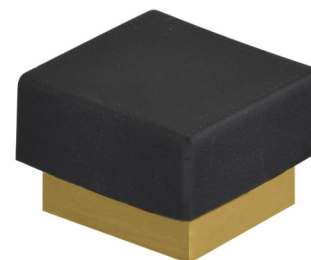

 TITANIUM GOLD

IN.13.356.TG
BATENTE DE CHÃO

Ref: 206401828168



 AÇO INOX SATINADO

IN.13.186
BATENTE MAGNÉTICO

Ref: 206401817440

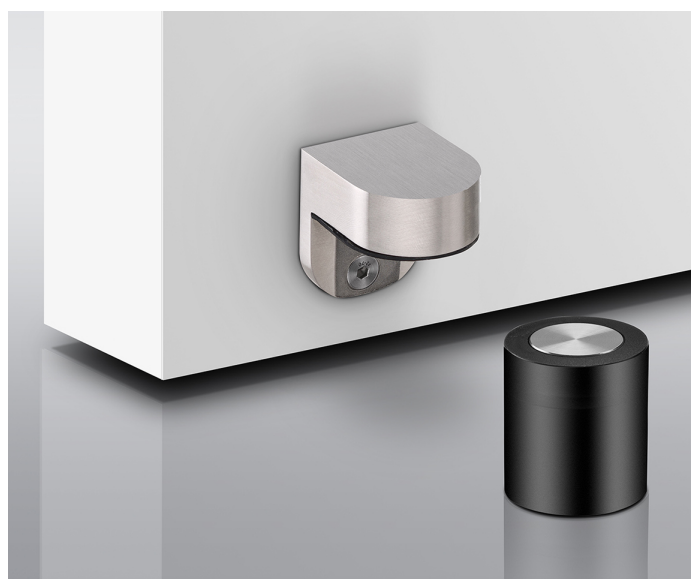

VEDAPORTAS E VEDANTES

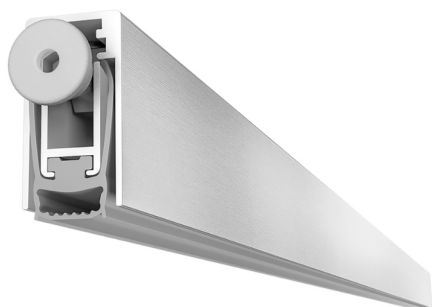

IN.06.002

VEDAPORTAS AUTOMÁTICO



Resistente ao fogo até **60 minutos**.

Com 52 dB de redução de ruído.

20 mm de queda máxima.

Ativador de metal articulado com tampa de nylon, ajustável com uma chave Allen de 3 mm.

Selante de silicone auto-extinguível.

Pode ser cortado.

Medidas disponíveis:

730 mm | Ref: 206402622328

830 mm | Ref: 206402622329

930 mm | Ref: 206402622330

1030 mm | Ref: 206402622331

1130 mm | Ref: 206402622332



IN.06.004

VEDAPORTAS AUTOMÁTICO COM ABAS



Fixação com parafusos feita nas abas laterais do perfil de alumínio.

Ativador de metal articulado com tampa de nylon, ajustável com uma chave allen de 3 mm.

Selante de silicone auto-extinguível.

Pode ser cortado.

Medidas disponíveis:

730 mm | Ref: 206402621872

830 mm | Ref: 206402621874

930 mm | Ref: 206402621875

1030 mm | Ref: 206402621876

1130 mm | Ref: 206402621877



TPE 4.10

VEDANTE AUTOADESIVO

● BEGE

Ref: 228605125017

● CASTANHO

Ref: 228605125016

● BRANCO

Ref: 228605125015

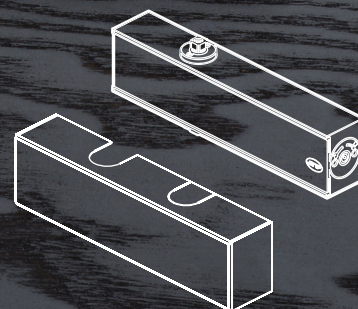
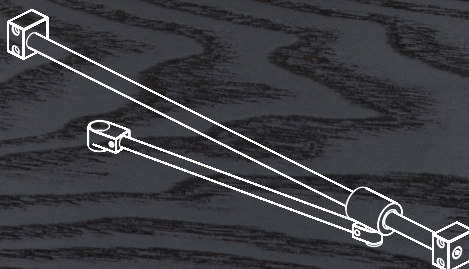
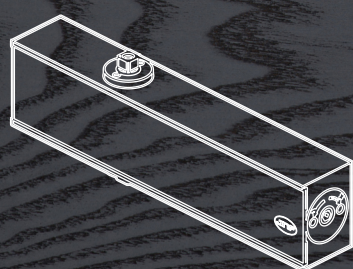

ML.21.765

MOLA DE PORTA AÉREA HIDRÁULICA DE SOBREPOR



Para portas:

- Largura máxima: 1250 mm
- Peso máximo: 120 kg
- Força: 2 a 5.
- Ajuste de força por mola.
- Mecanismo cremalheira e pinhão.
- Velocidade de fecho ajustável por válvula.
- Velocidade de fecho final ajustável por válvula.
- Ângulo de abertura 180°.
- Mola reversível.
- Certificado corta-fogo.

ESCOLHA A SUA COMBINAÇÃO

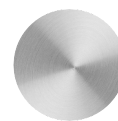

AÇO INOX
SÁTINADO



ML.21.765 | MOLA AÉREA
HIDRÁULICA DE SOBREPOR

Ref: 206409224168



IN.21.BD | BRAÇO DESIGN

Ref: 206401922863



21.765.HD | COBERTURA PARA MOLA

Ref: 206409228191

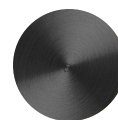

TITANIUM
BLACK (.TB)



ML.21.765 | MOLA AÉREA
HIDRÁULICA DE SOBREPOR

Ref: 206409224168



IN.21.BD.TB | BRAÇO DESIGN

Ref: 206401928189

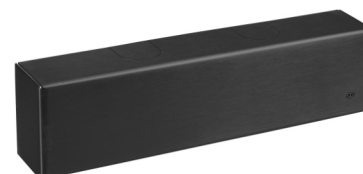

21.765.HD.TB | COBERTURA PARA MOLA

Ref: 206409228192



TITANIUM
GOLD (.TG)



ML.21.765 | MOLA AÉREA
HIDRÁULICA DE SOBREPOR

Ref: 206409224168



IN.21.BD.TG | BRAÇO DESIGN

Ref: 206401928190

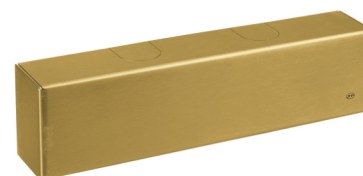

21.765.HD.TG | COBERTURA PARA MOLA

Ref: 206409228193

MOLAS DE PORTA

EMBUTIR

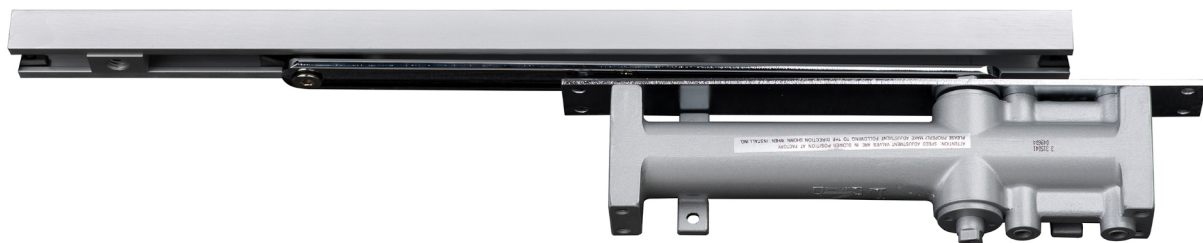

ML.21.801

MOLA AÉREA HIDRÁULICA DE EMBUTIR

● CINZENTO RAL 9006

Ref: 206409228052

● PRETO RAL 9005

Ref: 206409228053



Braço anti-vandalismo

Para portas:

- Largura máxima: 950 mm
- Peso máximo: 100 kg

Força: 3.

Mecanismo cremalheira e pinhão.

Velocidade de fecho ajustável por válvula.

Velocidade de fecho final ajustável por válvula.

Sistema de retenção na abertura: amovível.

Ângulo de abertura 120°.

Mola reversível.

MOLAS DE PORTA

SOBREPOR



ML.21.600

MOLA AÉREA HIDRAÚLICA DE SOBREPOR

Ref: 206409219743



Braço standard sem paragem.

Força: 2 a 4.

Para portas:

- Largura máxima: 1100 mm
- Peso máximo: 80 kg

Ajuste de força por mola.

Mecanismo cremalheira e pinhão.

Velocidade de fecho ajustável por válvula.

Velocidade de fecho final ajustável por válvula.

Ângulo de abertura 180°.

Mola reversível.

Certificado corta-fogo.



O FERROLHO- COMÉRCIO DE FERRAGENS, LDA

Braga

LOJA | SHOWROOM

R. Quinta do Carreiro, Lote 1,
4700-154, Frossos, Braga
+351 253 670 732
balcao@oferrolho.pt

Barcelos

LOJA

Lugar do Monte, Lote 1º de Maio, Loja B,
4755-232, Gilmonde, Barcelos
+351 253 837 253
barcelos@oferrolho.pt

www.oferrolho.pt

